

# ATMOSEAL®

DOCK FACILITY ENVIRONMENTAL PROTECTION SEALS

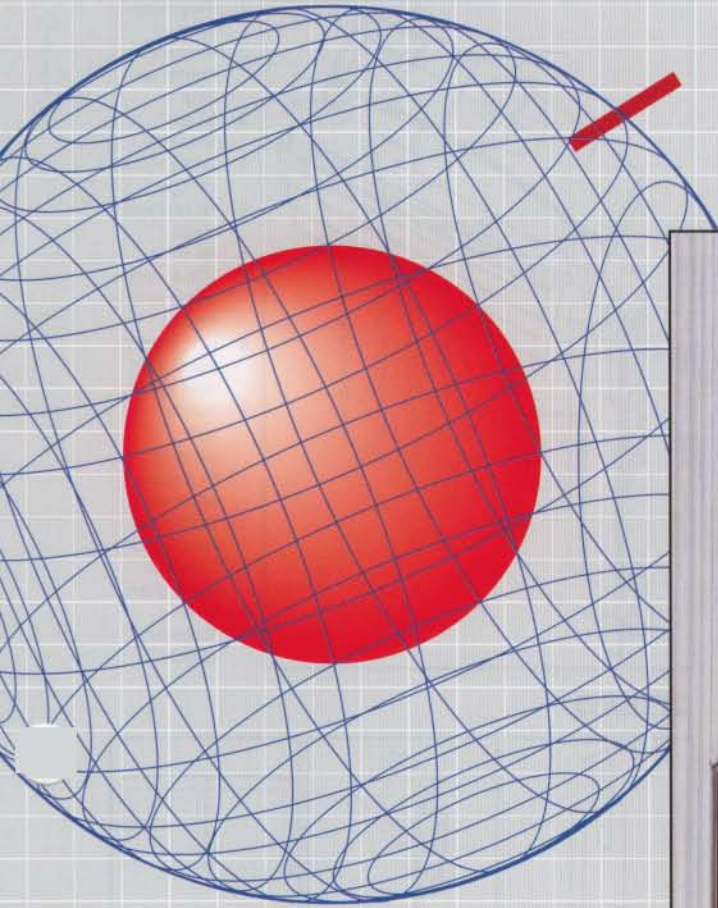

## **SUPERSEAL®** **SERIES 0401A** STATIONARY INFLATABLE TRUCK SHELTER

Designed for door openings up to 10'10"W x 11'0"H, the unique patented design of the Series 0401A eliminates wear and tear normally found on standard truck shelters. The Series 0401A is the optimum truck shelter solution which provides an air-tight seal around a wide range of different width and height trailers. The Series 0401A is the solution for any size door opening. Super Seal's exclusive "RipStop" fabric developed specifically for inflatables will give years of trouble free service. The Series 0401A creates an optimum seal that blocks out foul weather, insects, dust, and dirt, while saving money on energy costs. Inflatable truck shelters help productivity by increasing safety, protecting personnel, products, and equipment.

# ATMOSEAL®

## DOCK FACILITY ENVIRONMENTAL PROTECTION SEALS

### SERIES 0401A

#### The Company

**Super Seal's** name has long been associated with leadership, innovation, and quality in the dock seal and shelter industry. A skilled and experienced, sales, engineering, and management team, coupled with professional seamstresses, craftsmen and state-of-the-art production equipment assures a superior, long lasting product. Only the finest grade of environmentally friendly raw materials are used. Specially developed ultra high performance fabrics offer the ultimate in tear, abrasion, and weatherability resistance. A trained nationwide dealer network is available to assist and recommend a unit that will save you costly energy dollars and provide a safe and efficient working environment.

#### The Product

- Series 0401A standard dimensions for door openings up to 10'10"W x 11'H are 11'6" wide x 11'10" high (O.D.) with a 24" projection, 48" header air bag, and two (2) vertical air bags (one per side) 24" wide when inflated.
- Unique patented design (U.S.A. NOS. 4,916, 870:4, 821,468:DES 310,125 Canadian NO. 1,277,870).**
- Seals trailers 10'6" to 13'6" high from grade with a dock height of 48". Also seals trailers with widths from 7'6"W.
- Exclusive 16 oz. "RipStop" fabric developed specifically for inflatable units gives years of trouble free service (See fabric page).
- Can be part of a totally automated dock loading system.
- Gives full access to trailer opening.
- 18-20" projection in front of the dock bumper face is recommended to provide a proper seal.

#### Specifications

Stationary inflatable truck shelter(s) to be **SERIES 0401A** as manufactured by **Super Seal Mfg. Ltd.**, Woodbridge, Ontario. Stationary inflatable truck shelter(s) to be manufactured to fit door opening size(s) \_\_\_ft. wide x \_\_\_ft. high. Unit to consist of two (2) vertical air bags mounted to a top grade cedar framework covered with U.V. treated translucent rigid plastic. Vertical seals shall be complete with integral inflatable bottom corner seals with brass plated grommets for the venting of air and to assist in moisture drainage. When not in use the vertical air bags are stored behind a reinforced vinyl curtain with built-in spring stays for strength and rigidity. Inflatable header air bag to be full width over vertical seals mounted on a select kiln-dried pressurized wood frame. Inflatable header air bag in deflated mode is stored behind a reinforced vinyl curtain with a 4" yellow guide stripe to aid in the spotting of trailers. Unit to be supplied with 1/2 HP, 115V, 60/50 Hz, 1400 RPM motor/blower with a manual ON/OFF switch with neon pilot light. The motor/blower shall be mounted under a protective canopy constructed of cedar framework covered with U.V. treated translucent rigid plastic. The top canopy shall be peaked to allow for drainage. Unit is inflated by turning switch on and deflates automatically when unit is turned off by means of an internal pulley and retraction arm system for the verticals and a torsion roller assembly for the header. Unit to be manufactured of exclusive 16 oz. vinyl "RipStop" fabric. Double stitched, high strength twisted 4 ply 100% polyester bonded thread U.V. treated used for sewing throughout. Unit shall be furnished with protective steel guards and all necessary mounting hardware, galvanized to resist corrosion.

Air bag fabric to be \_\_\_oz. \_\_\_\_\_ Color: \_\_\_\_\_  
Unit size \_\_\_ft. wide, x \_\_\_ high (O.D.). Unit projection \_\_\_".

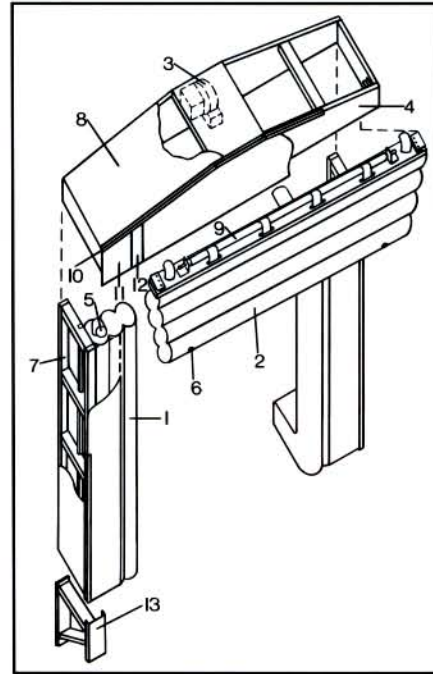

- Vertical air bags.
- Inflatable header air bag.
- Motor/Blower.
- Cedar wood canopy.
- Air connector ducts.
- Air vents.
- 2" x 4" cedar wood vertical frames.
- U.V. treated translucent rigid plastic.
- Torsion spring assembly.
- Aluminum angle trim.
- Reinforced vinyl curtain.
- 4" yellow guide stripe.
- Protective steel guards.

#### OPTIONS

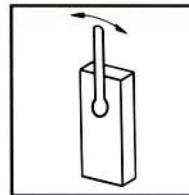

A. Automatic switch kit.

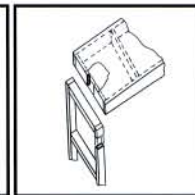

B. Tubular steel.

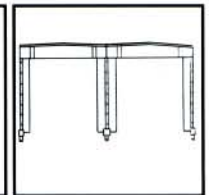

C. Common member.

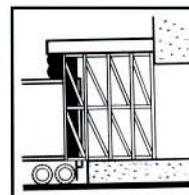

D. Extended projection.

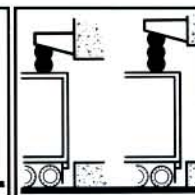

E. Higher unit.

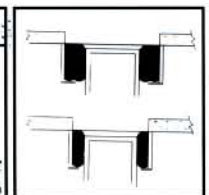

F. Wider unit.

DEALER IMPRINT

**SUPERSEAL®**

670 ROWNTREE DAIRY RD., WOODBRIDGE, ONTARIO, CANADA L4L 5T8

TEL: (905) 850-2929 TEL: 1-800-337-3239

FAX: (905) 850-2922 FAX: (905) 850-4440